

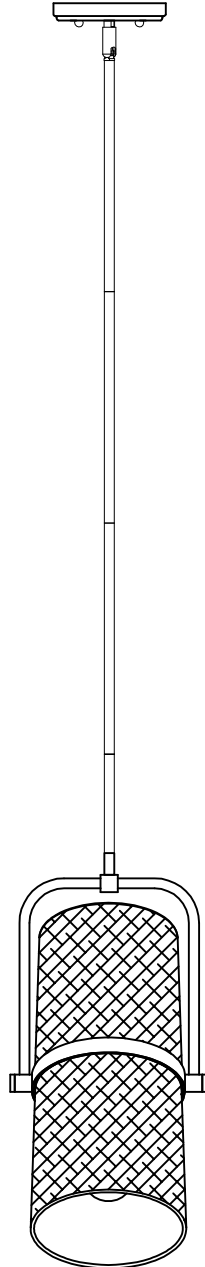

PRODUCT NAME: Oscar 2-Light Pendant
ITEM NUMBER: 11101OFBZAB



Please consult a qualified electrician for hanging fixture and wiring







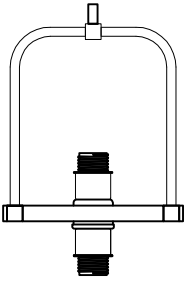
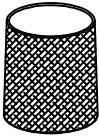

Light Source: 2 x E26 Medium Base 60W (Not Included)
Made in China/Hecho en China/Fabrique en China

EN Contents

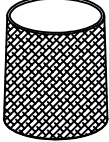
Before getting started, ensure the package contains the following components:

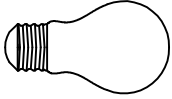
Antes de comenzar, asegurese de que el paquete contenga los siguientes componentes:

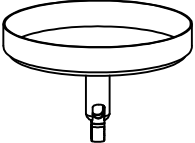
Avant de commencer, assurez-vous qu le paquet contient les composants suivants:

<p>(A)</p>	 <p>BODY</p>	<p>x1</p>	<p>(H)</p>	 <p>Fabric shade(Ø6.5")</p>	<p>x1</p>
<p>(B)</p>	 <p>MOUNTING BRACKET</p>	<p>x1</p>	<p>(I)</p>	 <p>Fabric shade(Ø7")</p>	<p>x1</p>
<p>(C)</p>	 <p>SCREW #8-32 x1"</p>	<p>x2</p>	<p>(J)</p>	 <p>BULB (Not Included)</p>	<p>x2</p>
<p>(D)</p>	 <p>WIRE NUTS</p>	<p>x3</p>	<p>(K)</p>	 <p>SOCKET RING</p>	<p>x2</p>
<p>(E)</p>	 <p>CANOPY</p>	<p>x1</p>			
<p>(F)</p>	 <p>BALL NUT</p>	<p>x2</p>			
<p>(G)</p>	 <p>STR04606BZ-NK x 1PCS STR04612BZ-NK x 3PCS</p>	<p>x1</p>			

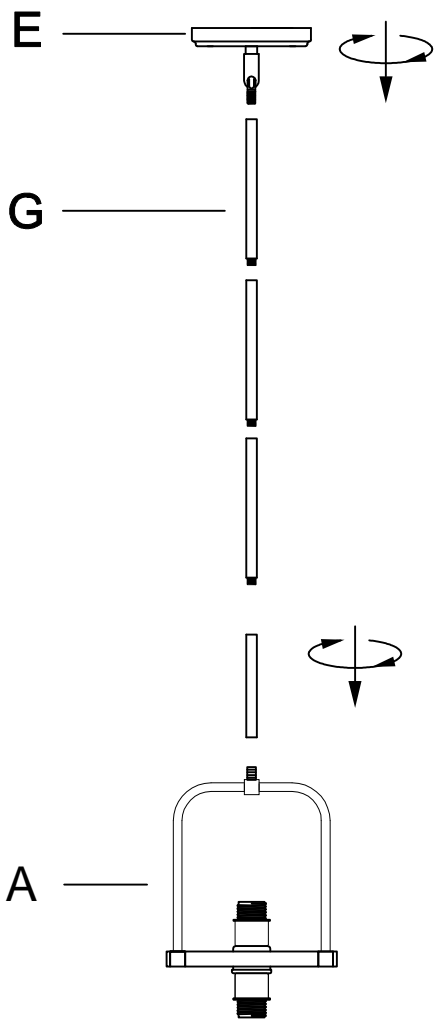

1. Run wire through stems and combine stem lengths to meet desired mounting height.

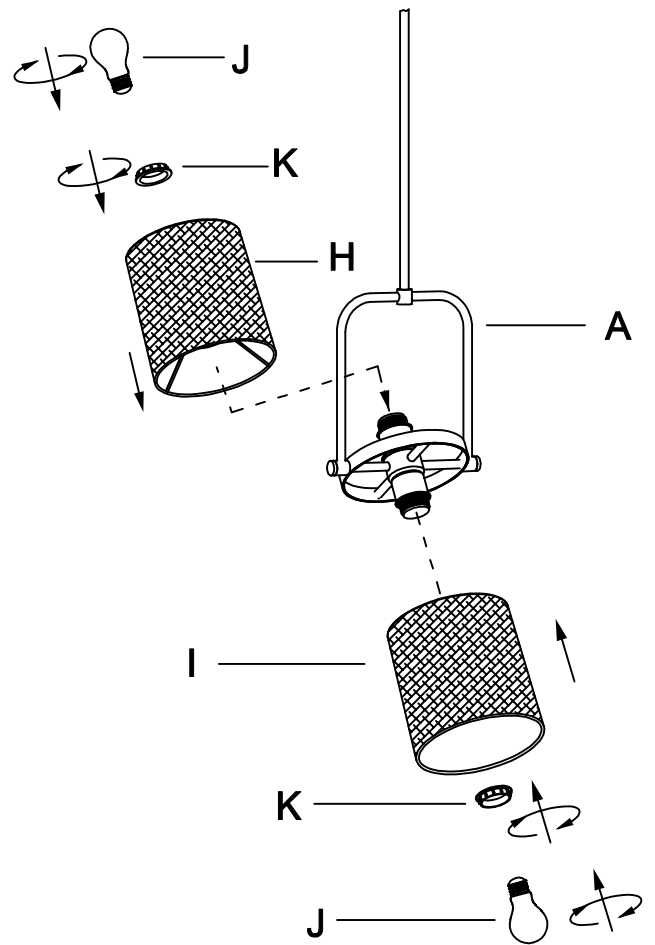

2.

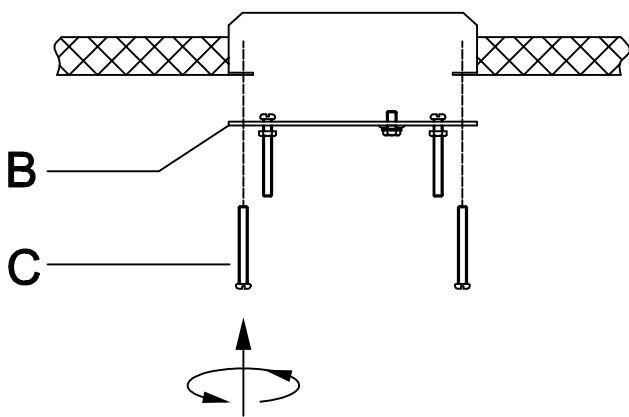

3.

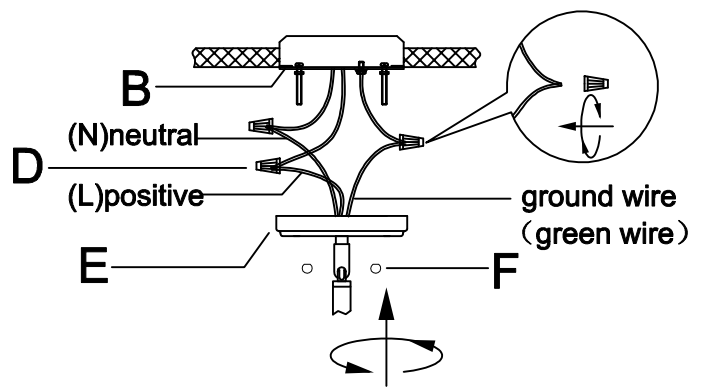

4.